

SPECIFICATIONS

Description	Digital Ultrasonic Cleaner	
Model	CD-4860	
Tank Capacity	6000 ml	Max.5000 ml / 1.3 gallon (US)
	1.6 gallon (US)	Min.3350 ml / 0.9 gallon (US)
Tank Size	32.3 x 20.5 x 9.9 cm / 12.7" x 8.1" x 3.9"	
Longest Item Fits inside Tank	34.0 cm / 13.4"	
Power	260 W (AC 100~120 V 60 Hz)	
	310 W (AC 220~240 V 50 Hz)	
	250 W (AC 100 V 50/60 Hz)	
Digital Timer	1 to 30-minute full range timer	
Temperature Settings	→ 40°C → 45°C → 50°C → 55°C → 60°C →	
Drainage	Drainage valve	
Ultrasonic Frequency	35,000 Hz	
Tank Material	Stainless steel SU304	
Housing Material	ABS	
Net Weight	5.4 kg / 11.9 lb	
Gross Weight	6.8 kg / 15.0 lb	
Unit Size	43.8 x 30.0 x 25.0 cm / 17.2" x 11.8" x 9.8"	
Inner Box Size	51.5 x 35.5 x 32.0 cm / 20.3" x 14.0" x 12.6"	
QTY per Master Carton	2 pcs.	
Master Carton Size	54.5 x 37.5 x 69.5 cm / 21.5" x 14.8" x 27.4"	

DIGITAL ULTRASONIC CLEANER

CD-4860

USER MANUAL

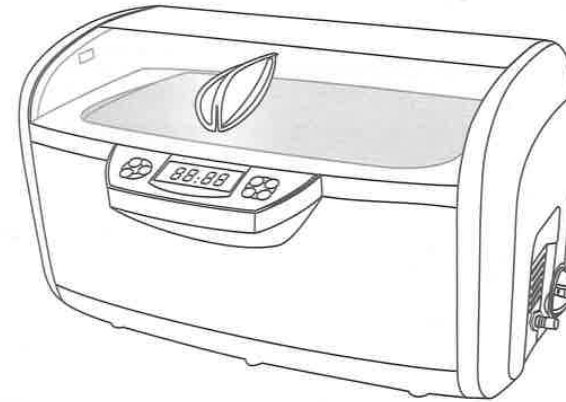

FEATURES

- | | | |
|-----------|---|--|
| 1 | Large tank capacity and opening size | Tank capacity 6,000 ml / 1.6 gallon.
Tank size 32.5 x 20.5 x 9.9 cm / 12.8" x 8.0" x 3.9" |
| 2 | Drainage valve | Convenient to use |
| 3 | Two industrial grade ultrasonic transducers | More uniform distribution of ultrasonic waves, strong cleaning, high durability |
| 4 | Two ceramic heaters | Even heating, durable |
| 5 | 2-color LED display | 1 to 30-minute full range timer, 5 temperature settings, working status indicators |
| 6 | Independent control circuit for each ultrasonic transducer | High efficiency, not susceptible to interference |
| 7 | Multiple circuit protectors | When overloaded or improperly used, the protectors shut down the power to certain areas to protect the machine |
| 8 | Cooling fan | Improves heat dissipation and beneficial for continuous operations |
| 9 | Moisture-proofed PCB | Capable for different working environments |
| 10 | Degas feature | Dissolves the solution quickly |
| 11 | Industrial IC | Better anti-interference performance |
| 12 | Housing made from engineering resin | Better water-proof and drop-proof properties |

INTRODUCTION

Use tap water. Special solutions are unnecessary in most cases.

Principles of ultrasonic cleaning:

Millions of tiny air bubbles are generated inside the liquid by high frequency vibration. The air bubbles burst inside the liquid and shake off the debris to achieve the cleaning effect.

- ⚠ Purified water or distilled water has the same cleaning effect as regular tap water for ultrasonic cleaning. Therefore using tap water is sufficient.
- When cleaning silver or copper items where oxidation has darkened the items, special solutions needs to be added to the water to remove the oxidation.

Main Features

- Tank opening 32.5 x 20.4 x 9.9 cm / 12.8" x 8.0" x 3.9". Longest item that can fit inside the tank is 34.0 cm / 13.4". 6,000 ml / 1.6 gallon tank capacity.
- 2 industrial grade ultrasonic transducers (2 x 70 W = 140 W), 2 ceramic heaters (2 x 80 W = 160 W).
- 2-color LED display. 1 to 30-minute full range timer. 5 temperature settings. Working status indicators. Degas feature.
- Independent control circuits and multiple circuit protections.
- Industrial grade IC. Moisture-proofed PCB. Cooling fan. Drainage valve. LED lights on both sides.

Read the Manual First

The manual should be carefully reviewed before starting to use the device. Warnings should be observed carefully. Please follow the manual for operations.

TABLE OF CONTENTS



Safety Precautions	1,2
Items Not Suitable for Ultrasonic Cleaning	2
Applications	3,4,5
Sample Applications	5,6
Product Structure and Accessories	7
Control Panel and Operations	8
Common Cleaning Methods	9,10,11
Operation Guidelines	11,12
Care and Maintenance	12,13
Specifications	14

SAFETY PRECAUTIONS

 **Keep it away from children!**

-  **This device is not intended for use by individuals including children with restricted physical, sensory or mental capacities or those with a lack of experience and/or knowledge, including children, unless they are supervised by an individual who is responsible for their safety or have received training in operating the device.**
- Please store the ultrasonic cleaner where it is not reachable by children.
- Danger to children! Danger for death through suffocation! Keep the packaging material away from children.

 **To prevent life-threatening electrical shock, please observe the following:**

-   **Danger of electrical shock!** Do not use while bathing. Never immerse the device or the power cord in water or other liquid.
- Danger of electrical shock!** Never touch the power plug with wet hands, especially when inserting or removing the plug.
- Danger of electrical shock!** If the unit has fallen into water during operation, do not touch the unit. Remove the power plug from the socket first.
- Danger of electrical shock!** Do not spray water or liquid over the device.
- Never operate the device unattended.
- Follow the manual to operate the device.
- Do not use components unapproved by the manufacturer.
- When removing the power cord from the socket, grab the power plug not the cord.
- To protect the power cord from damage, do not cause it to get caught by things such as a cupboard door or a chair leg; do not drag across a hot surface.
- If there is damage to the power plug, cord, housing, or other parts of the device, do not use the device.
- Do not disassemble the device, except by professionals.
- If the unit is damaged, non-operational or has fallen into water, take it to a qualified service provider.
- Remove the power plug from the socket
 - if malfunction occurs
 - before cleaning the device
 - if the device is not going to be used for prolonged period
 - after each use (recommended)
- The installation of an earth leakage circuit breaker with a rated tripping current of no more than 30 mA provides further protection against an electrical shock. The installation should only be carried out by a trained electrician.
- The device may come with a polarized plug (one blade is wider than the other) for certain countries. As a safety feature, this plug will fit into a polarized outlet only one way. If the plug does not fit fully in an outlet, reverse the plug. If it still does not fit, contact a qualified electrician.

SAFETY PRECAUTIONS

To prevent fire hazards, please observe the following:

- Never block the vents on the device. Keep the vents free from lint, hair and other materials.
- Do not place the device on a soft surface, such as a bed or a couch, where the vents could be blocked.
- Observe the other warnings in the previous section.

Other observations:

- Do not operate the product without filling the tank with water. Running dry will damage the unit.
- Do not plug in the power cord before adding water to the tank. Do not fill the tank above the Max line to avoid overspill.
- Do not use solution containing abrasive substances or strong corrosive chemical solution not recommended by the manufacturer or the supplier.
- Place the device on a dry and flat surface for operation.
- When the device is subjected to severe electromagnetic interference, it may malfunction, stop operating or lose control functions. If this happens, unplug the power cord then reinsert it to restart the device.

Items Not Suitable For Ultrasonic Cleaning

Soft Jewelry: Pearls, emerald, ivory, coral, agate, sea turtle shells, etc	These items are not hard, so scratches may occur during cleaning.
Welded, Plated and Glued Items: Welded or plated metal items, glued items	Ultrasonic cleaning may increase the gaps inside the welded joints, plated coating or glued items and may cause separation.
Watches: Except diver's watches with depth rating over 50 m (150 ft) .	Because the strong penetration capability of the ultrasonic waves, water may get into the watches if they are not truly waterproof. Use the watch stand we supply as a precaution.
Others: Glass, ceramic, camera filters with preexisting cracks.	Ultrasonic cleaning may increase the cracks pre-existed in the coating on the glasses, ceramic, and glass. If the items have no pre-existing cracks, then it is okay.

APPLICATIONS



1. Metal Decoration Manufacturers and Jewelry Makers

- With tap water only, ultrasonic cleaning can remove grease or abrasive powder from work-in-process metal items and keep them clean.
- Jewelry made with investment casting often has wax layer in addition to debris. Turning on the heater will raise the water temperature, melt the wax and improve the cleaning.



2. Optical Labs

- During edging and polishing, debris and abrasives can scratch lenses. Ultrasonic cleaning can effectively protect the lenses. Debris exists in the crevices of the frames during processing and polishing. Using ultrasonic cleaner and tap water can easily remove the debris



3. Biology, Chemical Laboratories:

- Labs can use ultrasonic cleaners to clean test tubes and other glass or metal containers to remove residual chemicals and debris that can affect the accuracy of the test results.



4. Medical Instrument Disinfection Rooms:

- Non-disposable medical instruments may have blood or organic tissues left after use. They need to be removed with ultrasonic cleaners before disinfection.



5. Dental Clinics:

- Dental clinics can use ultrasonic cleaners to clean dental instruments and to remove blood and small particles left on the instruments before disinfection.



6. Electrical Component Manufacturers

- Terminals on AC contactors and relays need to be kept clean to prevent sparking and non-contact. Ultrasonic cleaning is the most effective method to keep these parts cleaning.



7. Watch and Precision Metal Part Manufacturers

Machined watch components and other precision metal parts often have coolant and debris left on the surfaces. Ultrasonic cleaning can remove the debris and keep the parts clean.



8. Shooting Clubs

To reuse brass cartridges: Adding special solution can make fired brass useable and like new again.
Gun cleaning and care: Cleaning guns after shooting is time consuming. Adding special solution in the water and using ultrasonic cleaners can complete the cleaning better, quicker and easier than traditional methods.



9. Special Education Institutes / Kindergartens

Speech therapy tools or small toys that are reused need to be cleaned to prevent the growth and spread of bacteria. Ultrasonic cleaning can perform thorough cleaning by removing debris hidden inside small holes and crevices before disinfection.



10. Golf Clubs:

Cleaning the heads of golf clubs is a time consuming job. Using ultrasonic cleaning with the Enhanced Cleaning method can improve the effectiveness and efficiency.



11. Mobile Phone and Electronics Service Shops

PCB renewal: Non-operational electronics, after falling into water, or non-operational key pads can be cleaned with ultrasonic cleaners and pure alcohol to recover the functions. Use the Indirect Cleaning method for small-sized PCBs.



12. Homes

Silverware, silver, copper or brass decorations: It's difficult to clean debris hidden in the patterns with regular methods. Ultrasonic cleaning with 50 ml (3 tablespoons) of dish soap will clean the debris quickly.

For silver, copper or brass items with oxidation which has darkened the items, adding small amount of special solution

that can remove oxidation and using ultrasonic cleaning will restore the shine.

Children or baby items: Debris left in the small holes and crevices are difficult to clean. Bacteria and molds can grow. Using ultrasonic cleaning to deep clean the items before disinfection.

Crystal glasses and decorations, chandeliers: Ultrasonic cleaning can bring back the sparkles and make them look like new again.

Jewelry, eyewear, watch bands, shavers or razors: Ultrasonic cleaning can clean the debris in the crevices. It is quick and convenient.

This model has a large tank. When cleaning small items, the Indirect Cleaning method can be used with satisfactory results. Smaller ultrasonic cleaners can also do the job.



13. Printing Shops

Unblocking dried printer heads or ink cartridges:
Large printers and inkjet printers often have dried printer heads or ink cartridges ports. Replacing them with new ones is very costly. Adding acetone or special cleaning solution and using an ultrasonic cleaner with a couple of minutes of cleaning will remove the blockage and make them usable again.

Avoid acetone from contacting the plastic housing to prevent corrosion. Use Indirect Cleaning explained later and a glass or metal container for acetone.



14. Automotive Repair Shops

The Enhanced Cleaning method can be used to clean precision parts such as valves, injectors, gears and bearings. It cleans out debris in tiny holes and crevices effectively.



SAMPLE APPLICATIONS

JEWELRY	PERSONAL ITEMS	MEDICAL / DENTAL INSTRUMENTS
Necklaces, rings, earrings, bracelets, etc.	Eyeglasses, sunglasses, shaver heads, watch bands, diver's watches, dentures, etc.	Surgical instruments, pliers, handpieces, etc.

SAMPLE APPLICATIONS

PRECISION PARTS	SILVERWARE, SILVER, COPPER OR BRASS DECORATIONS	CHILDREN AND BABY ITEMS
		
Bearings, gears, valves, tools, fuel injectors, etc.	Silverware, silver, copper or brass decorations, etc.	Toys, baby items, speech therapy tools, etc.

LAB ITEMS	BRASS, GUN PARTS	PCB, INKJET CARTRIDGES
		
Test tubes, beakers, flasks, etc.	Reusable brass, gun parts, etc.	PCBs from mobile phones and MP4, ink cartridges, etc.

GOLF CLUBS	ELECTRICAL PARTS	LENSES, CRYSTALS
		
Golf clubs and golf balls	Terminals for relays and contactors	Lenses, crystals

PRODUCT STRUCTURE AND ACCESSORIES

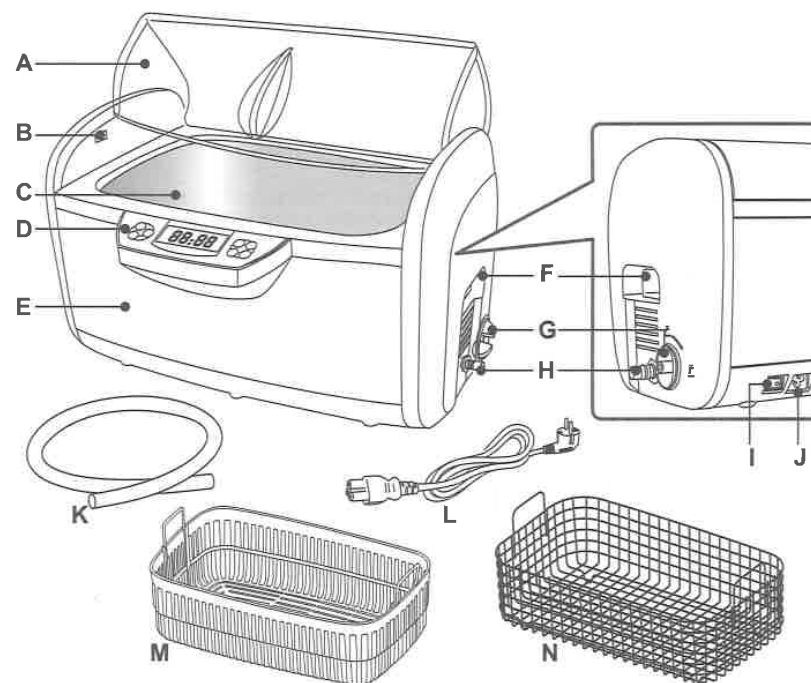

- A.** Lid **B.** LED lights **C.** Stainless steel tank **D.** Control panel
E. Housing **F.** Handles **G.** Drainage valve handle **H.** Drainage pipe
I. Power switch **J.** Power socket **K.** Hose **L.** Power cord
M. Plastic basket **N.** Stainless steel basket (optional)

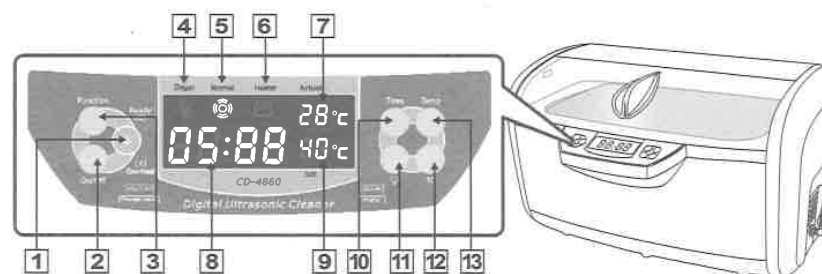

CONTROL PANEL AND OPERATIONS

1. Indicator Light - Working Status

Green – Ready (G): Normal working status, ready to use.



Red – Overheat (R): Under overheat protection. 15 minutes of waiting time is needed for the light to change from red to green. Work can resume afterwards.

2. On/Off Button - On/Off Switch

After powering on, the LED displays  which is the default time and the unit is ready with normal working status.

Press On/Off button once and the cleaning starts. The cleaning stops when the timer counts down to 00:00. If the unit needs to be stopped before the timer runs up, press On/Off button.

3. Function Button - Functions (Degas / Normal)

Press Function button,  illuminates, indicating Degas function is selected. Press On/Off button to start degassing.  will flash for 2 minutes, then the unit will return to the normal cleaning function. Pressing Function button before it ends will stop degassing. If additional degassing is needed after it ends, press Function button again.

Degas

When cleaning heavily soiled or greasy items or silver, copper or brass items, chemical solutions need to be added into the water. The solution may form many small droplets and take a long time to dissolve in the water. Newly added water may generate many air bubbles on the tank walls. These will reduce the cleaning effect in the beginning phase of ultrasonic cleaning. Turning on the degas function will dissipate the droplets and the air bubbles, usually in 2 minutes, and improve cleaning efficiency.



4. — Degas Status

 — Illuminated, the degas function is selected.  — Flashing, degassing is underway.

5. — Normal Cleaning Status

 — Illuminated, normal cleaning is underway.

6. — Heater Status

Press TC button,  flashes, indicating the heater is turned on. Press TC button again,  dims, indicating the heater is turned off.

7. Actual – Water temperature display. It displays the actual water temperature in the tank.

8. 05:00 Digital LED display of working time. It counts down after work is started.

9. Set – Set temperature display. Press Temp button to select one of the 5 set temperatures.

10. Time button — Timer quick set button. Press Time button, LED display shows 05:00. Each pressing increases it by 5 minutes

11. button — Timer decreasing button. Each pressing reduces the timer by 1 minute.

12. TC button — Heater button. Pressing TC button, flashes, indicating the heater is turned on. To cancel heating, press TC. dims, indicating the heater is turned off.

When the water reaches the set temperature 60°C (140°F), the heater will turn off automatically.

13. Temp button — Temperature set button. 5 set temperatures can be selected.

The default temperature is 40°C. Press Temp button to select the temperature in the following sequence: 

COMMON CLEANING METHODS

REGULAR CLEANING



Only tap water is needed.

Suitable Locations: metal decoration and jewelry makers, optical labs, biology / chemical labs, medical instrument cleaning rooms, dental clinics, homes, speech therapy clinics, kindergartens.

Cleaning Method:

1. Add water to the cleaning tank to a level between "MIN" and "MAX" lines and above the area to be cleaned.
2. Put the items to be cleaned inside the basket and put the basket inside the tank.
3. Turn the main switch on. Press TIME button to set the timer to 5 -10 minutes. Press On/Off button to start cleaning.

Notes on using the basket:

1. The basket reduces the friction between the items and the tank but a plastic basket absorbs about 30% of ultrasonic energy and reduces the cleaning effect
2. A metal basket absorbs less ultrasonic energy at about 8%.

INDIRECT CLEANING



Put the items in a separate container.

Use ultrasonic waves to penetrate the container to do the cleaning.

Suitable Locations: medical instrument sterilization rooms, precision electrical parts manufacturers, watch and precision parts manufacturers, mobile phone and electronics service shops, large printing shops.

Different industries use different fluids to be used inside the container:

1. Watch service shops - Watch oil (to prevent rust)
2. Medical instrument sterilization – Special solution (cleaning prior to sterilization)
3. Precision electrical parts – Hexane (to dissolve grease, to evaporate quickly)
4. Mobile phone and electronic service shops - Pure alcohol (to evaporate quickly)
5. Printing shops – Acetone are often used (to dissolve ink)
6. Homes - Rubbing alcohol (to remove odor, to clean and to disinfect at the same time)

Avoid acetone from contacting the plastic housing to prevent corrosion. Use Indirect Cleaning and a glass or metal container for acetone.

Cleaning Method:

1. Put the item inside a container. Add proper fluid to submerge the area to be cleaned.
2. Place the container in the tank directly. Add water to a level between MIN and MAX, not over the container.
3. Press TIME button to set the timer to 10 minutes. Press On/Off button to start cleaning. Ultrasonic waves will penetrate the container and clean the items.

Selection of container:

1. Plastic containers – Plastics are soft and will absorb about 30% of ultrasonic energy and reduce the cleaning effect.
2. Aluminum containers – Absorbs about 20% of ultrasonic energy.
3. Stainless steel containers – Absorbs about 8% of ultrasonic energy.

ENHANCED CLEANING

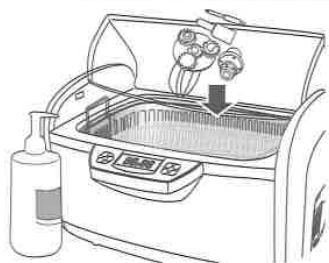

Debris accumulated over a long period of time, greasy or heavily soiled.

Suitable Locations: metal decoration and jewelry makers, hardware manufacturers, shooting clubs, homes, golf clubs, automotive repair shops.

Cleaning Method:

1. Large items can be put in the tank directly. Small items can be put in the basket then put in the tank. Do not put the items on top of each other to avoid rubbing during cleaning.
2. Add water to a level between MIN and MAX and above the area to be cleaned.
3. Add 50 ml (3 tablespoons) of dishwashing liquid.
4. Turn on the main switch. Press TEMP button to set the water temperature to 45°C (113°F). Press TC to turn on the heater, flashes. Close the lid. LED Actual displays actual water

temperature. When the water reaches the set temperature, dims, indicating the heater is turned off.

Warm water and dishwashing liquid can soften grease and improve cleaning efficiency.

5. Press TIME button to set the timer to 10 minutes. Press On/Off button to start cleaning. Grease will dissipate and appear to be like black smoke in the water.
6. When it stops, open the drainage valve to release the dirty water. Close the valve afterwards.
7. Clean the tank and add fresh water. Wash the items for another 3 minutes to remove the residual debris and the detergent.

SPECIAL CLEANING

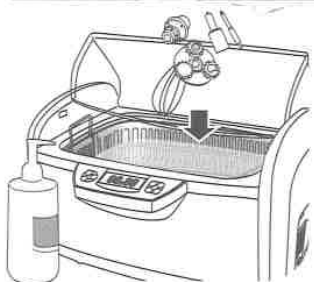

Silver, copper or brass items with oxidation which has darkened the items will need special cleaning.

Suitable Locations: silver, copper or brass product manufacturers, home, shooting clubs.

Cleaning Method:

1. Put the items in the basket and then in the tank, add water to a level between MIN and MAX and above the area to be cleaned.
2. Add special solution that can remove silver or copper oxidation according to the ratio recommended (typically 1:10). Use special solutions according to the instructions for brass cartridges.
3. Turn on the main switch. Press TEMP button to set the water temperature to 50°C (122°F). Press TC to turn on the heater, flashes. Close the lid. LED Actual displays actual water temperature. When the water temperature reaches the set temperature, dims, indicating the heater is turned off.

The heater has dual protection. It will be turned off automatically after 50 minutes.

4. Press TIME button to set the timer to 15 minutes.

5. Press Function button to select the degas function. button illuminates. Press On/Off to start degassing. After 2 minutes it changes over to normal cleaning automatically.
6. When it is done, remove the basket and the items. If there are large quantities of items and residual debris, reset the timer for 5 minutes and repeat the cleaning.
7. Follow steps 6 and 7 in the Enhanced Cleaning section to drain the dirty water, add fresh water, wash for 3 more minutes to remove the residual chemicals.

During cleaning, debris will come off the items like "smoke". Water will become murky. This method will remove silver or copper oxidation and debris in the decorating patterns and crevices and make the items like new again.

OPERATION GUIDELINES

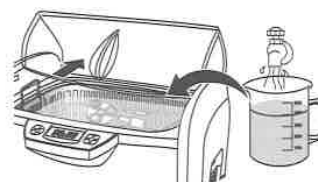

- 1 Open the lid as illustrated, put the items in the basket then put them in the cleaning tank. Add water to a level between MIN and MAX and above the area to be cleaned.

If the unit is turned on without water, ultrasonic energy will not be absorbed. This model also has high power. Once on for over 15 seconds, it may damage the unit or severely reduce the life of the unit.



- 2 Connect the power cord to an outlet and turn the switch on. LED display shows . This is the most common timer setting and working state. If the timer needs to be adjusted, press TIME button and button. The timer can be set between 1 to 30 minutes. Common cleaning times are 5, 10 or 15 minutes.

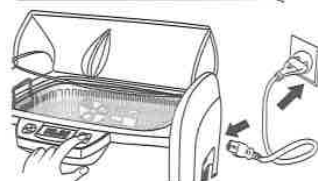



Prolonged cleaning time may result in:
a. Loosening of the screws if used.
b. Increasing pre-existing cracks.
c. Peeling of coating which was already separated.

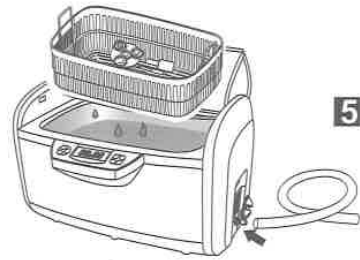
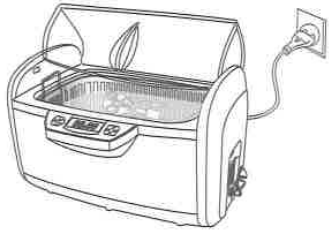

- 3 Press On/Off button to start cleaning. During cleaning, 2 sets of blue LED lights at the two sides of the unit illuminate, buzzing sound can be heard from the cleaning tank, indicating the cleaning is underway. Closing the lid will reduce the noise level. The digital timer will count down to show the remaining cleaning time. When it displays 00:00, the cleaning is done. To stop cleaning at any time, press On/Off button. The unit is designed with overheating protection to avoid extended and continuous operation for too long. When the red light is on, the unit will not turn on even if it is forced to. The unit will idle for about 20 minutes and can be restarted after the green light comes on.



4 Select one of the four cleaning methods recommended earlier.

a. When the heater is needed, press TEMP button to select one of the 5 preset temperatures. Press TC button,  flashes, indicating the heater is turned on. LED Actual displays actual water temperature. When the water reaches the set temperature,  dims, indicating the heater is turned off.

To ensure safety, the unit is designed with dual protections. The heater will be turned off automatically if it has been running for 50 minutes.

b. To speed up the mixing and to use less solution, use degas function. Press TIME button to set the timer to 10 minutes then press Function button,  illuminates. Press On/Off to start degassing. It changes over to normal cleaning automatically after 2 minutes.

c. When debris "smoke" is no longer visible, cleaning is done. If additional cleaning is needed, reset the timer and repeat the steps above.

5 When cleaning is completed, unplug the power cord, open the lid and retrieve the basket and the items. Connect the hose to the drainage pipe as shown beforehand. Open the drainage valve to drain the dirty water. Clean and wipe the tank dry. Close the drainage valve.

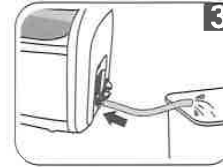

Do not keep water in the cleaning tank for a long time.
After cleaning is completed, open the drainage valve to drain the dirty water. Clean and wipe the tank dry.

Do not spray water over the housing.
Use a towel to wipe the tank and the housing dry.

Do not expose the unit under direct sun shine for a long time.
Keep the unit in a dry, cool and ventilated area.

CARE AND MAINTENANCE

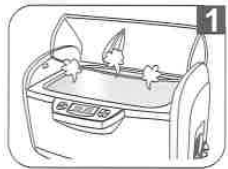

1 Do not turn on the unit without water in the tank.
Even though the unit is designed with multiple protections, if it is turned on for over 15 seconds without water in the tank, it may damage the unit or severely reduce the life of the unit.



2 Do not run the unit for extended time or continuously.
The unit is designed with overheat protection. If the unit has been running for 45 minutes, it is recommended to stop the unit for about 20 minutes to prolong the life of the unit.